







SYNTHESI

Tecnologia evoluta a servizio dell'uomo





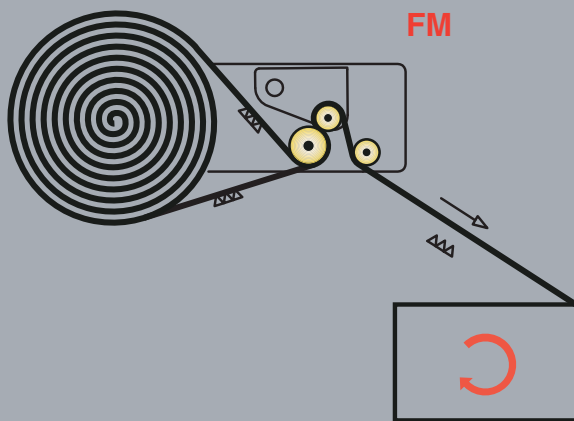
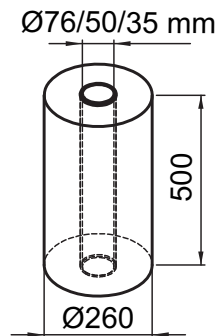

ATLANTA
S T R E T C H

SYNTHESI

-  Synthesi si caratterizza per l'utilizzo e l'applicazione del film estensibile già prestirato e per le sue funzioni semplificate.
-  Synthesi wird durch den Gebrauch von Vorgedehnter Stretchfolien und das Bedienpult mit einfacher Funktionen gekennzeichnet.
-  Synthesi is characterised by the use and application of already pre-stretch film and its simplified functions.
-  Synthesi se caracteriza por la utilización y aplicación de film pre-estirado y por su simplificación de funciones.
-  Synthési se caractérise pour l'utilisation et l'application de film pré-étiré et par ses fonctions simples mais complètes.







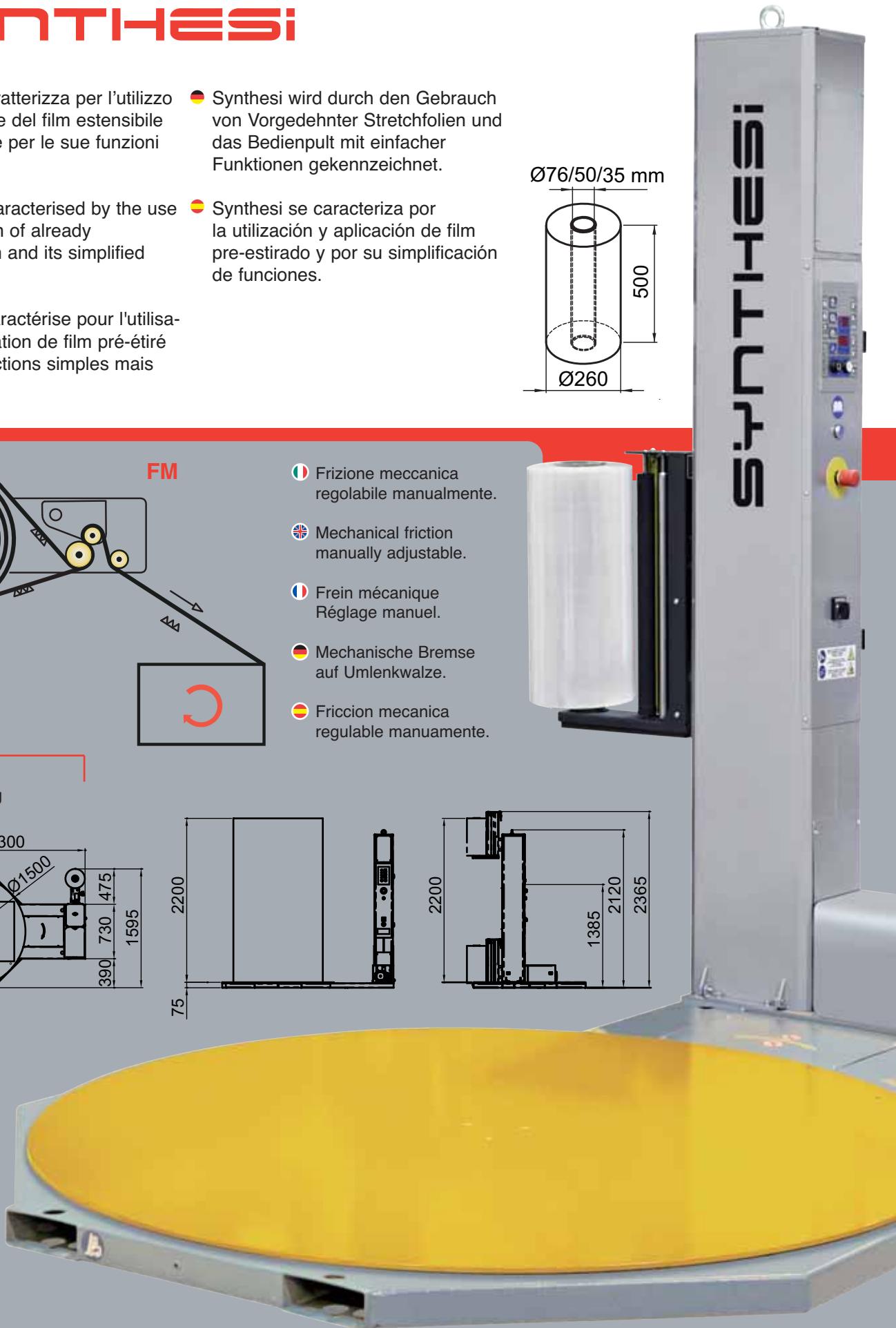
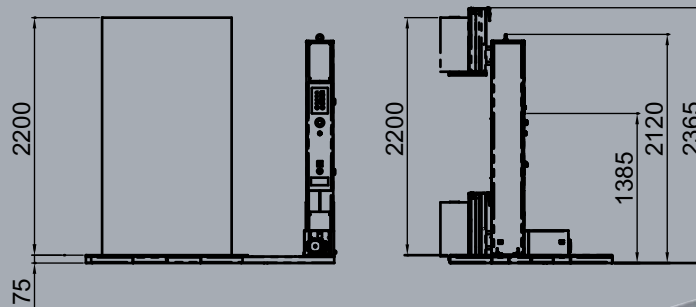
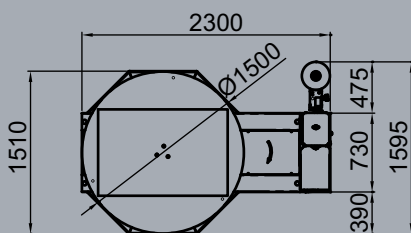

-  Frizione meccanica regolabile manualmente.
-  Mechanical friction manually adjustable.
-  Frein mécanique Réglage manuel.
-  Mechanische Bremse auf Umlenkwalze.
-  Friccion mecanica regulable manuamente.

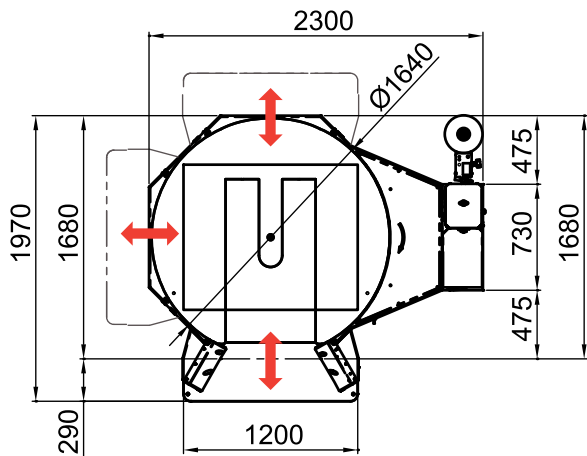
 350 Kg







SYNTHESI TP

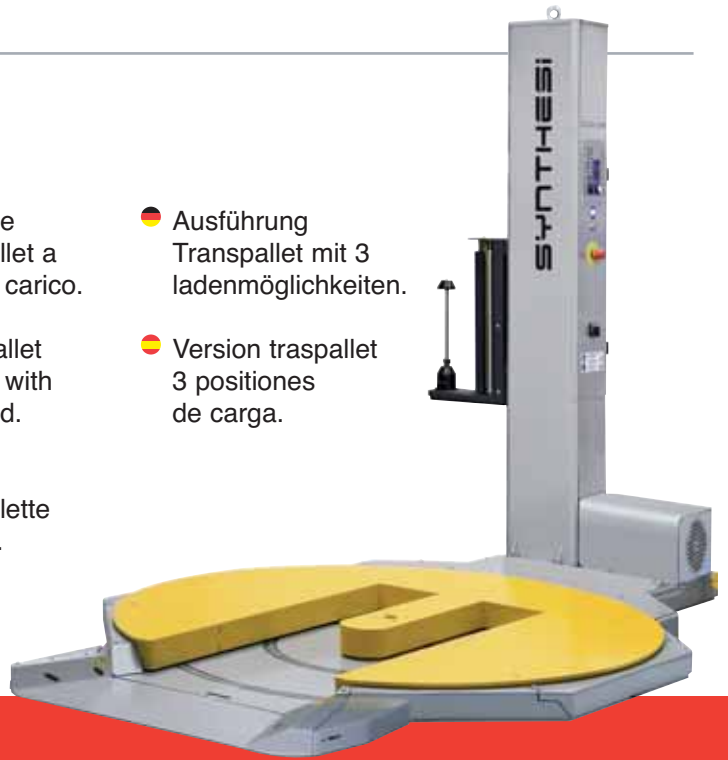

-  Versione transpallet a 3 vie di carico.
-  Ausführung Transpallet mit 3 ladenmöglichkeiten.
-  Transpallet version with 3 in feed.
-  Version traspallet 3 posiciones de carga.
-  Version transpalette 3 voies.



NEW

-  Pannello di controllo a multifunzione programmabile.
-  Multifunction programmable control panel.
-  Panneau de contrôle multifonction programmable.
-  Multifunktion programmierbare Systemsteuerung.
-  Panel de control programable multifunción.

-  **Parametri facilmente regolabili tramite pannello.**
 - Velocità di rotazione tavola.
 - Velocità salita e discesa carrello regolabili separatamente.
 - Programmazione separata giri alti e bassi.
 - Fotocellula lettura altezza pallet.
 - Avvolgimento con esclusione fotocellula (Altimetro)
 - Ciclo salita / salita e discesa.
 - Ciclo mettfoglio.
 - Cicli manuali: Rotazione tavola, Salita e discesa carrello portabobina.

-  **Parameters easily adjustable from the panel.**
 - Table rotation speed.
 - Independently adjustable upwards and downwards carriage speeds.
 - Separate programming for high and low rpm.
 - Pallet height photoelectric cell reading.
 - Wrapping cycles with altimeter (Without photocell).
 - Ascent / Ascent and Descent cycle.
 - Sheet placement cycle.
 - Manual cycles: Table rotation, Roll carriage ascent and descent.

-  **Paramètres ajustables au pupitre**
 - Vitesse de rotation de la table.
 - Vitesse montée et descente chariot réglable separement.
 - Tours droits haut et bas séparés.
 - Débordement supérieur du film.
 - Cycle banderolage avec altimetre (sans photocellule).
 - Cycle montée et descente.
 - Cycle montée et descente seule.

- Cycle dépose de coiffe.
- Cycles manuels: Rotation table Montée/arrêt du chariot Descente /arrêt du chariot.

-  **Einstellbare Parameter von Bedienungstafel:**
 - Stufenlos regelbare Drehtellergeschwindigkeit.
 - Regelbare Hubschlittengeschwindigkeiten. Auf- und Abwärts getrennt einstellbar.
 - Einstellbare Anzahl für Fuß- und Kopfwicklungen.
 - Fozelle zur selbständigen Höhenabfrage.
 - Wickelprogramme mit Höhenmesser (Ohne Fozelle).
 - Kreuzspiral und Spiral.
 - Regendichtprogramm
 - Manueller Zyklusablauf: Drehtellerdrehung. Hubschlitzen Auf- und Abwärts.

-  **Parámetros fácilmente regulables mediante panel.**
 - Velocidad de rotacion mesa.
 - Velocidad subida y bajada carro regulable por separado.
 - Programacion separada de vueltas altas y baja.
 - Fotocelula lectura altura palet.
 - Envolvimiento con exclusión de la fotocelula (Altimetro)
 - Ciclo subida / subida y bajada.
 - Ciclo metefolio.
 - Ciclos manuales: Rotacion mesa. Subida y bajada carro porta bobina.

Dati Tecnici**SYNTHESE****SYNTHESE TP**

Potenza totale installata	0.85 Kw	0.85 Kw
Tensione alimentazione standard	230V monofase - 50/60 Hz	230V monofase - 50/60 Hz
Protezione impianto elettrico e motori	IP 54	IP 54
Dimensione max pallet	800 x 1200 mm	1000 x 1200 mm
Altezza std pallet	2200 mm	2200 mm
Portata max	1500 Kg	1200 Kg
Diametro tavola	1500 mm	1640 mm

Technical Characteristics**SYNTHESE****SYNTHESE TP**

Total installed power	0.85 Kw	0.85 Kw
Standard input voltage	230V mono-phase - 50/60 Hz	230V mono-phase - 50/60 Hz
Electrical system and motors protection	IP 54	IP 54
Max pallet dimensions	800 x 1200 mm	1000 x 1200 mm
Standard pallet height	2200 mm	2200 mm
Max capacity	1500 Kg	1200 Kg
Table diameter	1500 mm	1640 mm

Données Techniques**SYNTHESE****SYNTHESE TP**

Puissance totale installée	0.85 Kw	0.85 Kw
Tension alimentation standard	230V mono-phase - 50/60 Hz	230V mono-phase - 50/60 Hz
Protection installation électrique et moteurs	IP 54	IP 54
Dimensions maximum palette	800 x 1200 mm	1000 x 1200 mm
Hauteur standard palette	2200 mm	2200 mm
Portée maximum	1500 Kg	1200 Kg
Diamètre de la table	1500 mm	1640 mm

Technische Daten**SYNTHESE****SYNTHESE TP**

Gesamte Leistung	0.85 Kw	0.85 Kw
Anschluss-Spannung	230V mono-phase - 50/60 Hz	230V mono-phase - 50/60 Hz
Elektroanlage und Motore Schutzart	IP 54	IP 54
Max. Palettenabmessung	800 x 1200 mm	1000 x 1200 mm
Max. Standard Wickelhöhe	2200 mm	2200 mm
Max. Ladungsgewicht	1500 Kg	1200 Kg
Drehteller Durchmesser	1500 mm	1640 mm

Datos Técnicos**SYNTHESE****SYNTHESE TP**

Potencia total instalada	0.85 Kw	0.85 Kw
Tension de alimentacion estandar	230V mono-phase - 50/60 Hz	230V mono-phase - 50/60 Hz
Proteccion montaje electrico y motores	IP 54	IP 54
Dimension max palet	800 x 1200 mm	1000 x 1200 mm
Altura estandar palet	2200 mm	2200 mm
Peso max	1500 Kg	1200 Kg
Diametro mesa	1500 mm	1640 mm

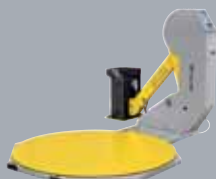
SFERA**MYTHO****MYTHO-A****REVOLUTION****OMEGA**

ATLANTA
S T R E T C H

ATLANTA STRETCH S.p.A
Via Chiesa di Camerano, 30
47824 Poggio Berni (Rimini)
ITALIA

Tel. +39 0541 627145
Fax +39 0541 627220
www.atlantastretch.com
sales@atlantastretch.com

Atlanta Deutschland GmbH
Atlanta Stretch Sweden AB
Atlanta Packaging SA - Spain
Atlanta Packaging Ltd - UK
Atlanta France Sarl
Atlanta Packaging Systems Australasia